

product technical sheet

collection	BOUNCE
code	EVLACOU
description	Soft polyurethane washbasin with lower shelf in beechwood.
certifications	TUV system certification UNI EN ISO 9001. Compliant to the Regulation 305/2011 and to the rule EN 14688.
features	White color. Smooth surface finish. Overflow not included. Waste coupling included, made of chrome-plated brass with always open tap made of white Corian. Available, on demand, the waste coupling click clack. Inside frame made of carbon-steel with galvanic treatment. Table top made of beechwood th 30 mm.
size	880 x 365 x 210 mm
installation	Install on a table top using 4 screws M6 (included). To fix the table top to the wall use "concealed brackets for shelves", not included. Hole on the table top to insert the concealed brackets for shelves: Ø 14 mm. Choose the correct type of fasteneres considering the type of wall. Connect to the water drain. Check the solidity of the installation of the product, and make sure about a safely installation.
finishes	White color. Waste coupling in white Corian. Shelf in natural beechwood.
maintenance	Check periodically the correct fixation of the washbasin. A proper maintenance and care of polyurethane products can contribute to have a better durability. For the cleaning, we suggest to use only water and neutral soap, do not use sponges or abrasive clothes. If you expose the product to chemical products, such as solvents, alcohol-based cleaners, bleach, oils, acids or bases, can be influenced the durability of the material, with the possibility to have a chemical deterioration, swellings, deformations, stains or alteration of the properties of the material, reducing its duration. Avoid prolonged and direct exposure to sun's UV rays. Do not expose to temperatures higher than 80°C. The material is not self-extinguishing. A regular cleaning, UV protection, an adequate managing of mechanical loads, and avoid the exposure

ST_PRODOTTO: EVLACOU - REV. 02 of 09/11/2023 - 17/12/24 - APPROVED T.D.

product technical sheet

to chemicals products, contribute to prolonging the life of the material.

materials

Polyurethane, steel, beechwood.

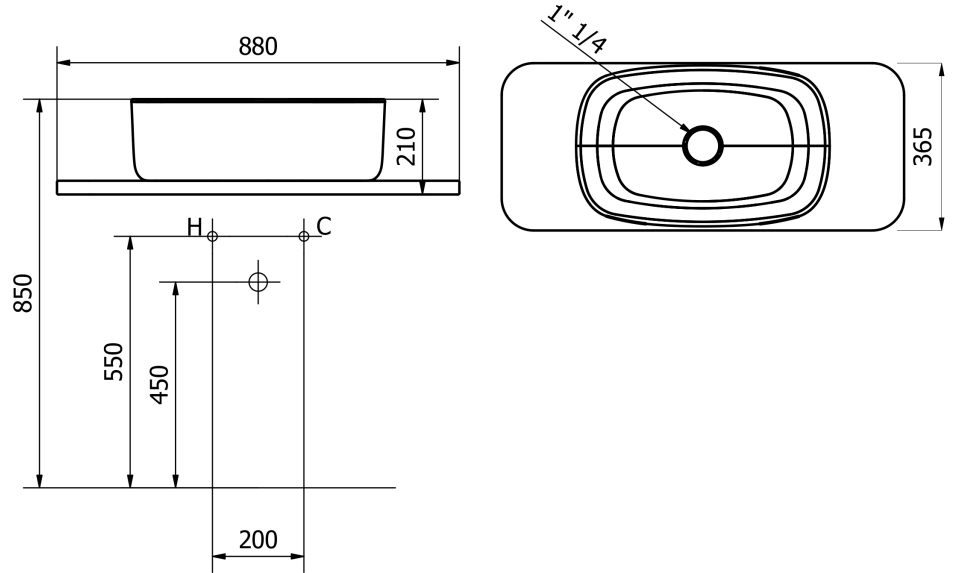

ST_PRODOTTO: EVLACOU - REV. 02 of 09/11/2023 - 17/12/24 - APPROVED T.D.